

# *Grizzly* *Industrial, Inc.*®

## **ELECTRIC GUITAR MODEL H3123 INSTRUCTION MANUAL**

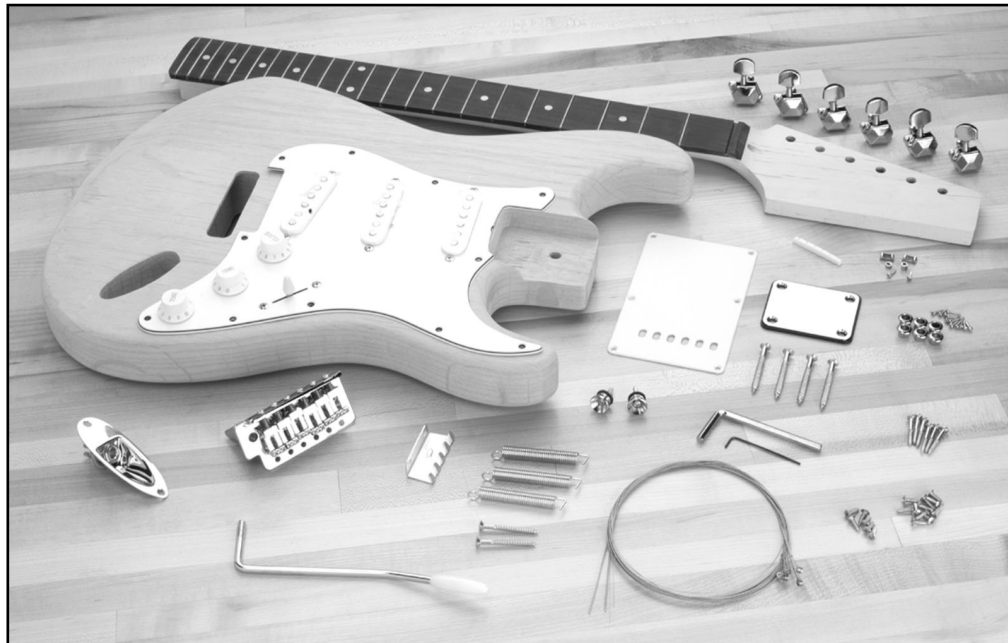

COPYRIGHT © JULY, 2003 BY GRIZZLY INDUSTRIAL, INC.

**WARNING: NO PORTION OF THIS MANUAL MAY BE REPRODUCED IN ANY SHAPE OR FORM WITHOUT THE WRITTEN APPROVAL OF GRIZZLY INDUSTRIAL, INC.**

#505203624 PRINTED IN JAPAN

#### **ONLINE MANUAL DISCLAIMER**

THE INFORMATION IN THIS MANUAL REPRESENTS THE CONFIGURATION OF THE MACHINE AS IT IS CURRENTLY BEING SHIPPED. THE MACHINE CONFIGURATION CAN CHANGE AS PRODUCT IMPROVEMENTS ARE INCORPORATED. IF YOU OWN AN EARLIER VERSION OF THE MACHINE, THIS MANUAL MAY NOT EXACTLY DEPICT YOUR MACHINE. CONTACT CUSTOMER SERVICE IF YOU HAVE ANY QUESTIONS ABOUT DIFFERENCES. PREVIOUS VERSIONS ARE NOT AVAILABLE ONLINE.

# WARNING

Some dust created by power sanding, sawing, grinding, drilling, and other construction activities contains chemicals known to the State of California to cause cancer, birth defects or other reproductive harm. Some examples of these chemicals are:

- Lead from lead-based paints.
- Crystalline silica from bricks, cement, and other masonry products.
- Arsenic and chromium from chemically treated lumber.

Your risk from these exposures varies, depending on how often you do this type of work. To reduce your exposure to these chemicals: work in a well ventilated area, and work with approved safety equipment, such as those dust masks that are specially designed to filter out microscopic particles.

# TABLE OF CONTENTS

<b>SECTION 1: SAFETY</b> .....	<b>2</b>
<b>SECTION 2: INTRODUCTION</b> .....	<b>3</b>
<b>SECTION 3: PARTS INVENTORY</b> .....	<b>4</b>
<b>SECTION 4: SANDING/FINISHING</b> .....	<b>8</b>
Supplies/Tools .....	8
Guitar Body .....	8
Neck .....	9
Masking Tape Areas .....	9
Painting/Finishing .....	10
<b>SECTION 5: HARDWARE</b> .....	<b>11</b>
Tuning Machines .....	11
Neck to Body .....	11
Pick Guard .....	12
Tremolo Bridge.....	13
Strap Button .....	15
Audio Jack .....	16
Winding Strings .....	16
String Retainers .....	17
Mounting Back Plate .....	18
Mounting Pick Guard .....	18
<b>SECTION 6: FINAL SET UP</b> .....	<b>19</b>
Neck Adjustment .....	19
String Height .....	19
Pick Up Height .....	21
Tremolo Arm .....	22
Tuning .....	22
<b>SECTION 7: REFERENCE INFO</b> .....	<b>24</b>
General.....	24
Aftermarket Accessories .....	24
Warranty & Returns .....	26

# SECTION 1: SAFETY

---

---

## WARNING

Always wear safety glasses or goggles when operating equipment. Everyday glasses or reading glasses are not safety glasses. Be certain the safety glasses you wear meet the appropriate standards of the American National Standards Institute (ANSI).

Because there are various ways to cut and join wood, you can make substitutions for the methods stated in this plan. We try to suggest the easiest methods possible. However, only you know your skills with each piece of machinery. Never compromise your safety by using a cutting method with which you are not comfortable. Instead, find an alternative approach that will yield the same result.

## WARNING

These instructions assume that you are intimately familiar with the safe operation and use of woodworking machinery and woodworking tools, and understand the techniques used to reproduce this project. If you do not qualify for both of these criteria, **STOP building this project for your own safety.** Read and understand the owners manual for the machinery you intend to use, take a woodworking class or visit your local library for more information. Woodworking machinery and tools are inherently dangerous because they use sharp edges that can and will cause serious personal injury including amputation and death. Do not underestimate the ability of these tools and machinery to cause injury. Never operate any tool without all guards in place and always wear approved safety glasses. For your own safety, please heed this warning.

# SECTION 2: INTRODUCTION

---

---

We are proud to offer the Model H3123 Electric Guitar Kit. This kit is part of a growing Grizzly family of fine woodworking products. When assembled according to the guidelines set forth in this manual, you can expect years of enjoyment from this guitar.

We are pleased to provide this manual with the Model H3123. It was written to guide you through assembly, review safety considerations, and cover general information. It represents our effort to produce the best documentation possible.

If you have any comments regarding this manual, please write to us at the address below:

Grizzly Industrial, Inc.  
c/o Technical Documentation  
P.O. Box 2069  
Bellingham, WA 98227-2069

Most importantly, we stand behind our products. If you have any questions or parts requests, please call or write us at the location listed below.

Grizzly Industrial, Inc.  
1203 Lycoming Mall Circle  
Muncy, PA 17756  
Phone: (570) 546-9663  
Fax: (800) 438-5901  
E-Mail: [techsupport@grizzly.com](mailto:techsupport@grizzly.com)  
Web Site: <http://www.grizzly.com>

The specifications, drawings, and photographs illustrated in this manual represent the Model H3123 as supplied when the manual was prepared. However, owing to Grizzly's policy of continuous improvement, changes may be made at any time with no obligation on the part of Grizzly. For your convenience, we always keep current Grizzly manuals available on our website at [www.grizzly.com](http://www.grizzly.com). Any updates to products will be reflected in these manuals as soon as they are complete. Visit our site often to check for the latest updates to this manual!



# SECTION 3: PARTS INVENTORY

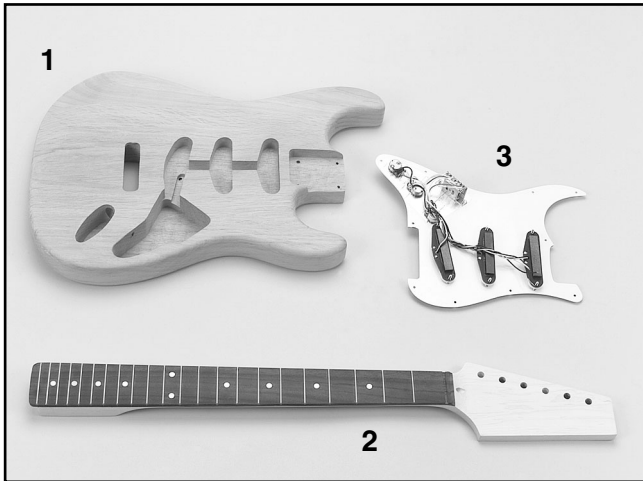

Figure 1. Boxed components.

Boxed Components	QTY
1. Guitar Body	1
2. Guitar Neck	1
3. Pickguard	1

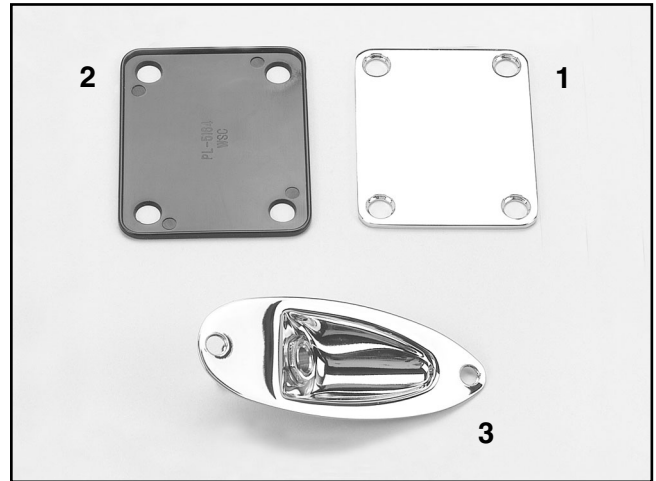
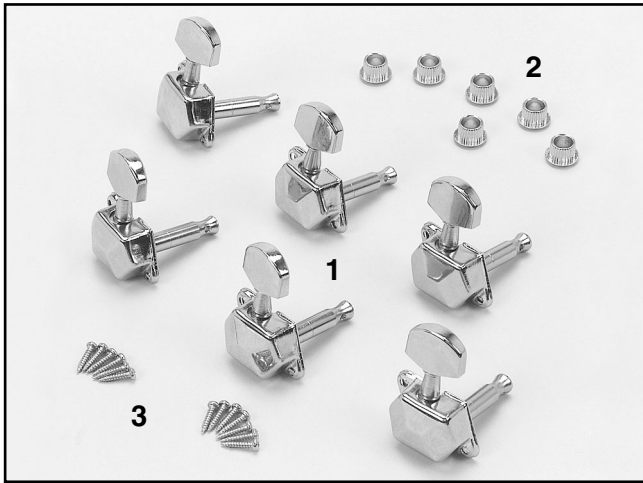

Figure 2. Bag 1 components.

Bag 1	QTY
1. Silver Neckplate	1
2. Black Neckplate Setter	1
3. Audio Output Jack	1



**Figure 3.** Bag 2 components.

<b>Bag 2</b>		<b>QTY</b>
1.	Tuning Machines	6
2.	Bushings	6
3.	#1 x 5/32" Pan Head Screw	12

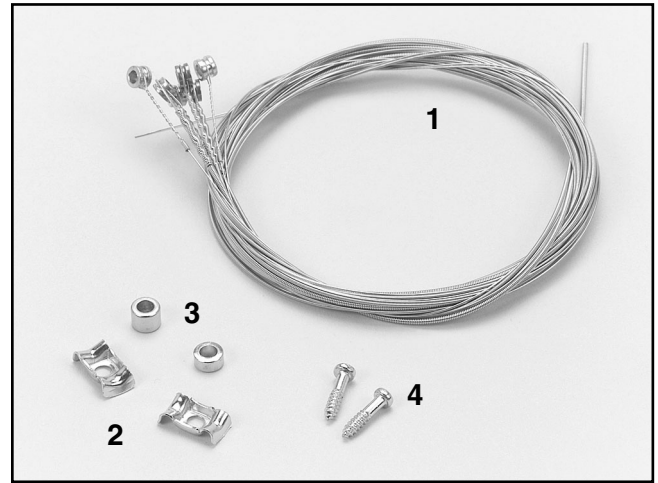

**Figure 4.** Bag 3 components.

<b>Bag 3</b>		<b>QTY</b>
1.	String Set	1
2.	String Guides	2
3.	String Guide Risers	2
4.	#2 x 3/8" Pan Head Screw	2

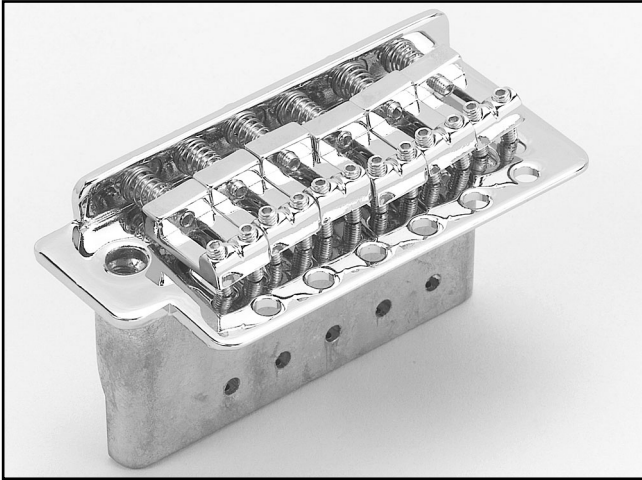

**Figure 5.** Tremolo bridge.

**Bag 4**  
Tremolo Bridge

**QTY**  
1



**Figure 6.** Audio patch cable.

**Bag 5**  
Audio Patch Cable

**QTY**  
1



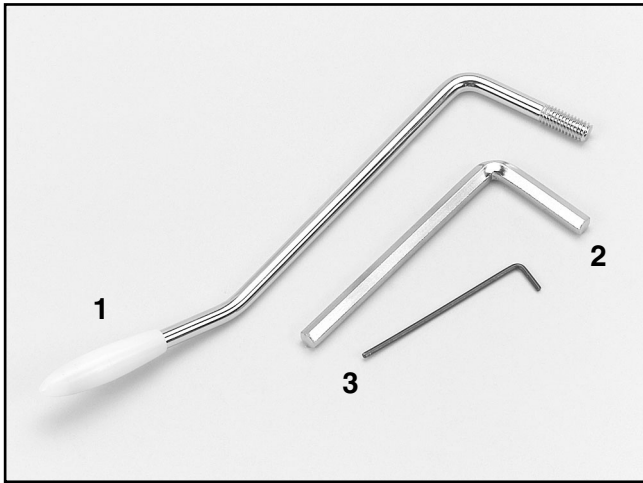

Figure 7. Bag 6 components.

<b>Bag 6</b>		<b>QTY</b>
1.	Tremolo Arm	1
2.	5mm Allen Wrench	1
3.	1.5mm Allen Wrench	1

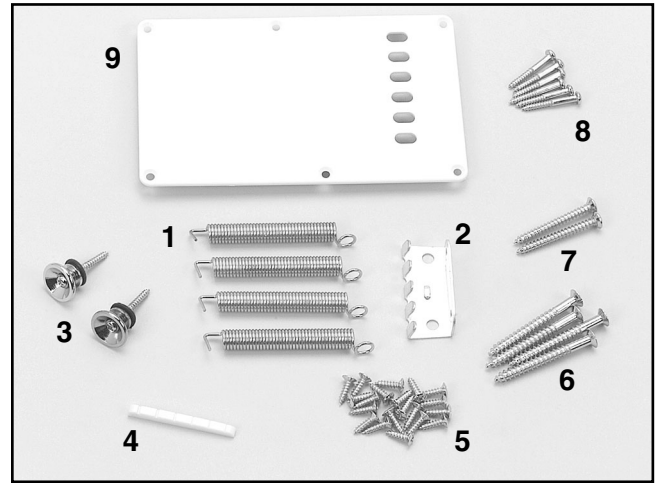

Figure 8. Bag 7 components.

<b>Bag 7</b>		<b>QTY</b>
1.	Springs	4
2.	Spring Hanger	1
3.	Strap Buttons	2
4.	String Nut	1
5.	#4 x 3/8" Flat Head Screws	20
6.	#10 x 1 3/4" Flat Head Screws	4
7.	#7 x 1 1/2" Flat Head Screws	2
8.	#4 1 " Pan Head Screws	6
9.	Back Plate	1

# SECTION 4: SANDING/FINISHING

---

---

## Supplies/Tools

---

---

The majority of the wooden components in this kit are fully machined from the factory and are ready for assembly. A small amount of drilling, sanding and light machining will need to be performed to complete the guitar.

### Recommended Tools & Supplies:

- Phillips Screwdriver
- Needle-Nose Pliers
- Electric Drill
- Drill Bit Set
- Soldering Iron & Solder
- #180, #240, and #320 Aluminum-Oxide Sanding Paper
- Sanding Block
- Masking Tape
- Painting/Finishing Supplies
- Coat Hanger
- C-Clamp
- 5MM Allen Wrench (Supplied)
- 1.5MM Allen Wrench (Supplied)
- Tack Cloth
- Coping, Jig, or Scroll Saw (Optional)



## Guitar Body

---

---

The guitar body has been machined and rough sanded at the factory; however, no finish has been applied.

### To sand the guitar body:

1. **Wear an ANSI-approved dust mask and safety glasses when sanding wood!**
2. Using either an electric palm sander or a sanding block, sand the guitar body (EXCEPT the guitar neck notch and other recessed areas) with #180 grit aluminum-oxide sanding paper until there is a consistent scratch pattern on the entire surface.
3. Sand the guitar body with a #240 grit sanding paper until there is a consistent scratch pattern on the entire surface.
4. Sand the guitar body with a #320 grit sanding paper until there is a consistent scratch pattern on the entire surface.
5. Wipe the guitar body with a damp cloth. Wiping the workpiece with a damp cloth before the final sanding helps to “raise” the wood grain; thus, allowing the “raised” grain to be sanded smooth.
6. Once the guitar body is dry, repeat **step 4**.
7. Wipe the guitar body with a tack cloth to remove all remaining sanding dust.



---

---

# Neck

Like the guitar body, the guitar neck is mostly complete from the factory; however, the neck headstock can be customized to reflect personal taste. Additional cutting, inlay, or design work can give an otherwise ordinary guitar that custom look that sets it apart from others! Note—*Take your time with this sub-section and consider testing ideas in scrap wood before performing the work on the actual headstock.*

## To sand the guitar neck:

1. **Wear an ANSI-approved dust mask and safety glasses when sanding wood!**
2. Perform any custom cutting, inlay, or design work to the neck headstock.
3. Using the sanding technique described in the previous sub-section, sand the entire guitar neck, EXCEPT for the fingerboard surface (**Figure 9**). Note—*Sanding the fingerboard will affect the playability of the guitar, and could lead to unrepairable damage.*



---

---

# Masking Tape Areas

In preparation for the finish coating, the following parts of the guitar (**Figures 9 & 10**) need to be covered with masking tape:

- Neck Pocket
- Fingerboard
- Truss Rod Cut-Out

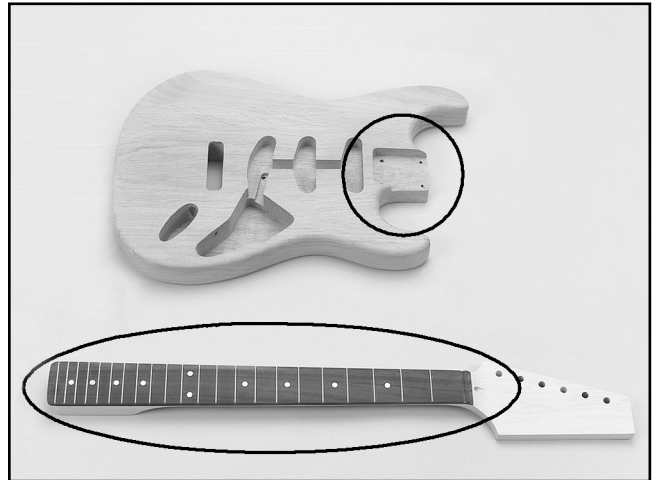

**Figure 9.** Neck pocket and fingerboard areas.

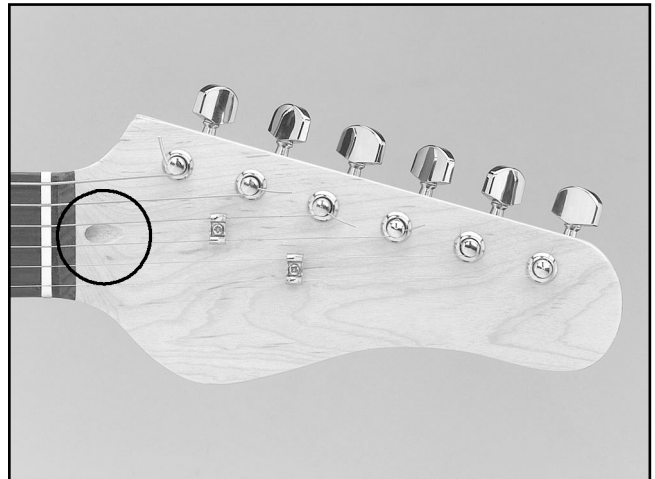

**Figure 10.** Truss rod area (hardware should not be installed at this time).

Use a small stick of wood to carefully press all the masking tape edges securely to the guitar pieces. The finish coat can seep under these edges, especially near corners, uneven edges, and where the frets meet the fingerboard. Note—*Failure to correctly mask off these areas could result in unrepairable damage to the guitar.*



# Painting/Finishing

---

---

Painting and finishing supplies are not supplied with the guitar kit. Note—*The guitar body is made from alder wood and the neck from maple wood. Clear finishes such as lacquer look exceptionally stunning and glossy on these nice types of wood.*

## Painting/Finishing Tips:

- **Always work in a well ventilated area when using finishing materials.**
  - **Wear an ANSI-approved respirator mask and safety glasses when using finishing materials!**
  - Fabricate hooks from shirt hangers to suspend the guitar components during the finishing process.
  - Several thinner coats usually produce a nicer finish than one heavy coat. Note—*Always follow the finish manufacturer's instructions.*
- Dust particles suspended in the air will settle on wet finishes, resulting in less than satisfactory results. To avoid this problem:
    1. Leave the room where the finishing will take place completely undisturbed for 24 hours prior to applying the finish.
    2. Have the guitar components positioned for the finish application upon entering the room.
    3. Avoid making unnecessary movements upon entering the finish room.
    4. Apply the finish to the desired guitar parts and immediately leave the finish room.
    5. DO NOT return to the room until the specified drying time has elapsed.
  - Always follow the finish manufacturer's instructions.



# SECTION 5: HARDWARE

## Tuning Machines

Each tuning machine consists of the machine head, a bushing, and two wood screws.

### To install the tuning machines:

1. Slide each of the six bushings into the pre-drilled holes on the headstock. Note—*Make sure the bushings are slid into the pre-drilled holes through the front face of the headstock.*
2. Slide each machine head through the bushings from the back face of the headstock.
3. Align the machine heads and secure their position on the headstock with masking tape.
4. Using a  $\frac{3}{32}$ " drill bit, drill  $\frac{3}{8}$ " deep holes straight through the two holes in the machine heads. Note—*Drilling the holes deeper than  $\frac{3}{8}$ " could result in drilling out through the front face of the headstock.*
5. Secure the machine heads to the guitar headstock with the included twelve  $\frac{1}{2}$ " wood screws (**Figure 11**).

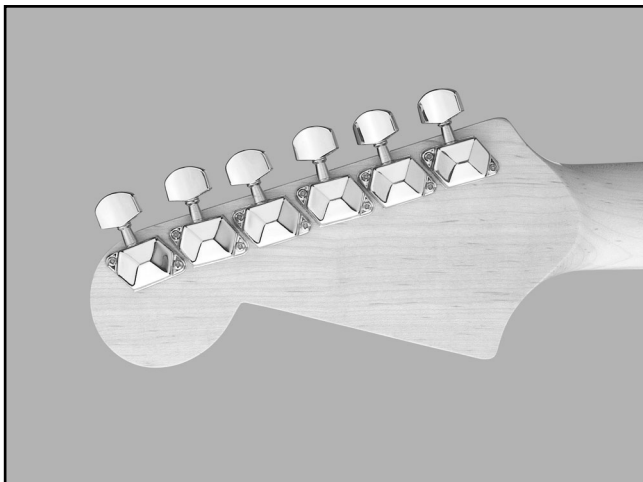

**Figure 11.** Correctly positioned tuning machines.



## Neck to Body

### To attach the neck to the guitar body:

1. Remove the masking tape from the neck pocket.
2. Place the neck into the neck pocket (**Figure 12**). Note—*Make sure the neck is fully seated into the neck pocket. No gaps should be visible between the neck and the body.*

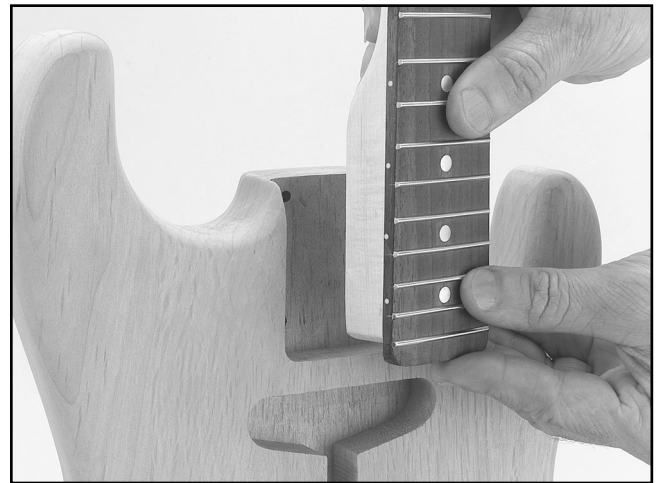

**Figure 12.** The neck should fit snugly into the neck pocket.

3. Hold the neck to the body with a C-clamp.
  - If the back side of the fingerboard does not sit flush against the guitar body, then the neck pocket needs to be deepened or material needs to be removed from the back of the neck. A router is the easiest tool for performing this task; however, a sharp chisel will also work. Note—*Use a pattern cutting router bit when removing material from the neck pocket. Use a straight cutting router bit when removing material from the back of the neck.*

- Using a  $\frac{5}{32}$ " drill bit, drill  $1\frac{3}{4}$ " deep holes straight through the four holes in the back of the body (**Figure 13**). Note—*Drilling the holes deeper than  $1\frac{3}{4}$ " could result in drilling out through the fingerboard.*

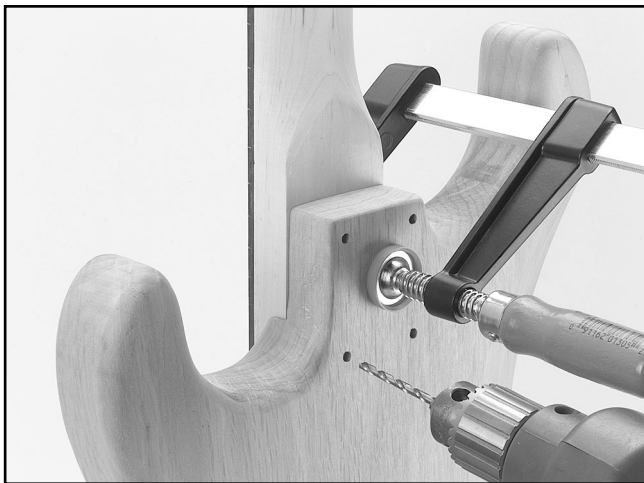

**Figure 13.** Drilling the screw holes.

- Place the black neckplate setter and the silver neckplate over the holes on the back of the guitar body.
- Secure the neckplate assembly, the guitar body, and the neck together with the included  $1\frac{3}{4}$ " wood screws (**Figure 14**). DO NOT use glue.



**Figure 14.** Correctly attached neck.



---

---

## Pick Guard

To attach the pick guard to the guitar body:

- Push one white and one black wire through the hole shown in **Figure 15**.

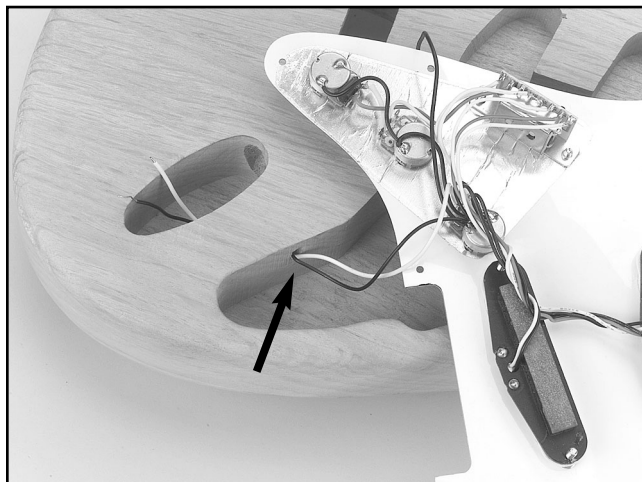

**Figure 15.** Pick guard wires.

- Push the remaining black wire through the hole shown in **Figure 16**.

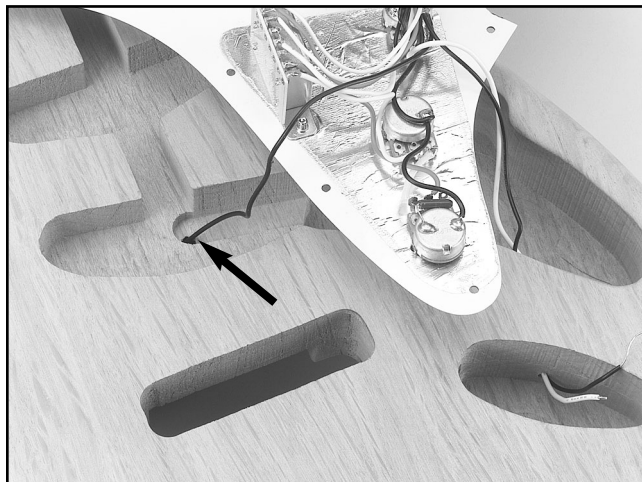

**Figure 16.** Pick guard wire.

3. Secure the wires with masking tape so they do not fall back out through the holes.
4. Align the pick guard on the guitar body as shown in **Figure 17**. Pay special attention to the neck cutout alignment on the body.



**Figure 17.** Pick guard alignment.

5. Secure the position of the pick guard to the body with masking tape.
6. DO NOT drill the screws at this time! Final adjustments need to be made after installing and winding the strings.



## Tremolo Bridge

**To attach the tremolo bridge to the guitar body:**

1. Place the tremolo bridge in the cut-out shown in **Figure 18**.

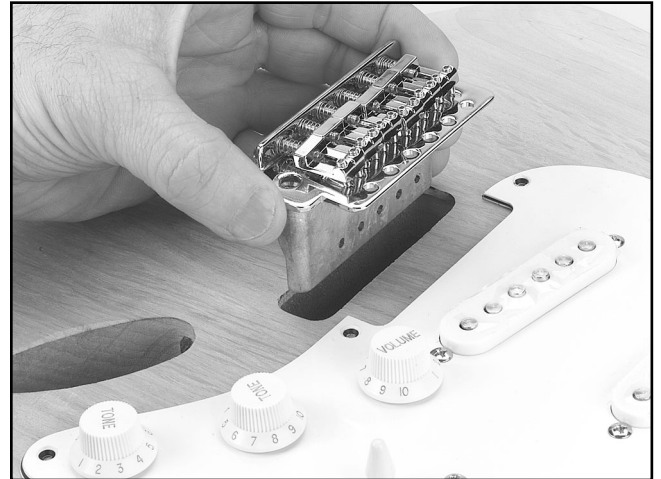

**Figure 18.** Tremolo bridge placement.

2. The tremolo bridge is correctly positioned when the distance between the center of the 12th fret and the front edge of the tremolo bridge are precisely  $12\frac{7}{16}$ " apart (**Figure 19**).

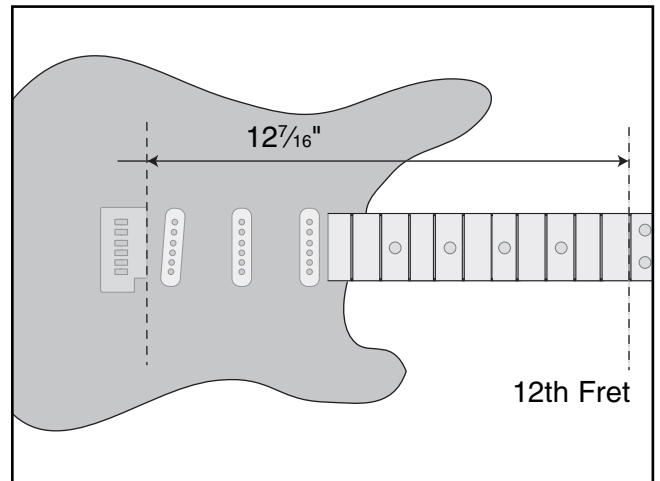

**Figure 19.** Correct distance between the 12th fret and the tremolo bridge.



3. Attach pieces of sewing thread to the 1st and the 6th machine head and tape the opposite ends to the edges of the tremolo bridge.
4. Adjust the tremolo bridge so there is an equal amount of space between the fingerboard edges and the threads (**Figure 20**).

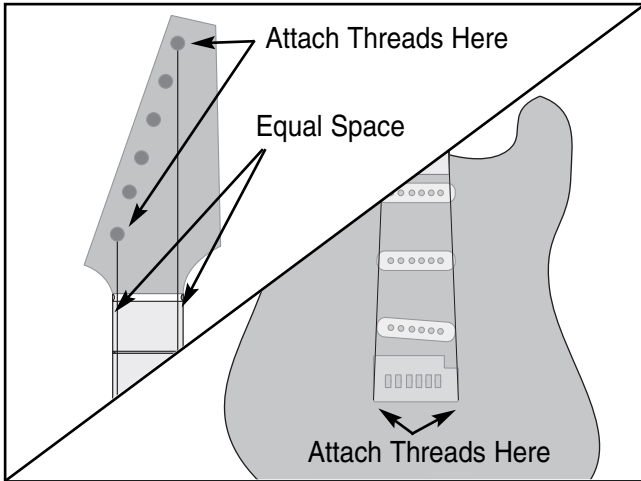

**Figure 20.** Checking neck alignment with tremolo bridge.

5. When all adjustments are correct, secure the position of the tremolo bridge to the guitar body with masking tape.
6. Using a  $\frac{3}{32}$ " drill bit, drill  $\frac{1}{2}$ " deep holes straight through the six holes in the tremolo bridge (**Figure 21**). Note—*Drilling the holes deeper than  $\frac{1}{2}$ " could result in drilling out through the back of the guitar body.*



**Figure 21.** Drilling the bridge mounting holes.

7. Secure the tremolo bridge to the guitar body with the included six  $\frac{1}{2}$ " wood screws.
8. Flip the guitar body over and place the spring hanger in the cavity as shown in **Figure 22**.

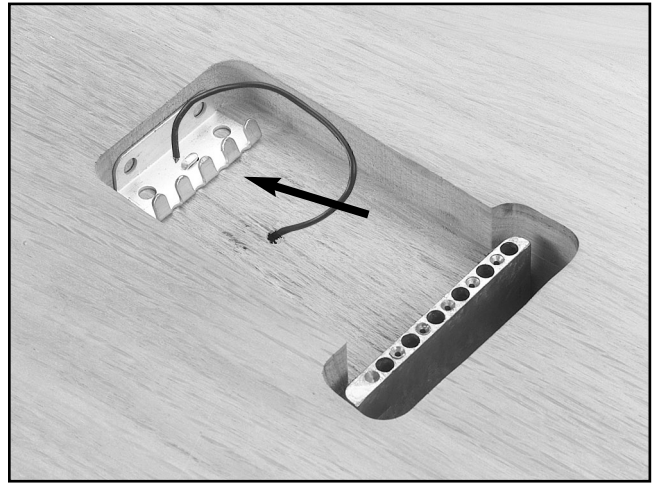

**Figure 22.** Spring hanger placement.

9. Secure the position of the spring hanger to the guitar body with masking tape.
10. Using a  $\frac{1}{8}$ " drill bit, drill  $1\frac{1}{2}$ " deep holes straight through the two holes in the spring hanger (**Figure 23**). Note—*DO NOT drill the holes deeper than  $1\frac{1}{2}$ ".*

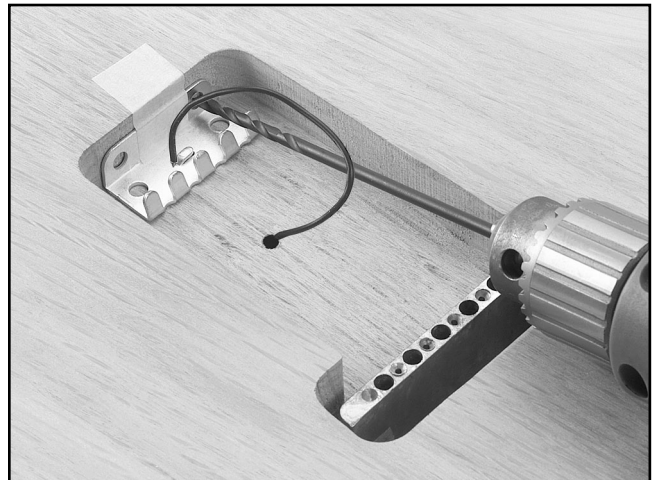

**Figure 23.** Drilling the spring hanger mounting holes.



11. Solder the black wire to the spring hanger.
12. Secure the spring hanger to the guitar body with the included two 1½" wood screws.
13. Hang the three springs from the spring hanger to the tremolo bridge as shown in **Figure 24**.

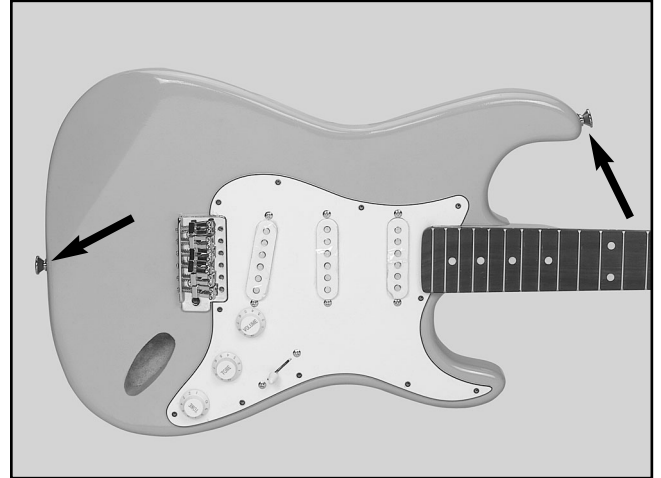

**Figure 24.** Correct spring placement.



## Strap Button

The strap buttons are positioned on the guitar as shown in **Figure 25**.



**Figure 25.** Strap buttons.

**To attach the strap buttons to the guitar body:**

1. Using a  $\frac{3}{32}$ " drill bit, drill  $\frac{3}{4}$ " deep holes at each of the mounting locations.
2. Secure the strap buttons to the guitar body with the included two  $\frac{3}{4}$ " wood screws.



# Audio Jack

## To attach the audio jack to the guitar body:

1. Solder the wires shown in **Figure 26** to the tabs on the audio jack.

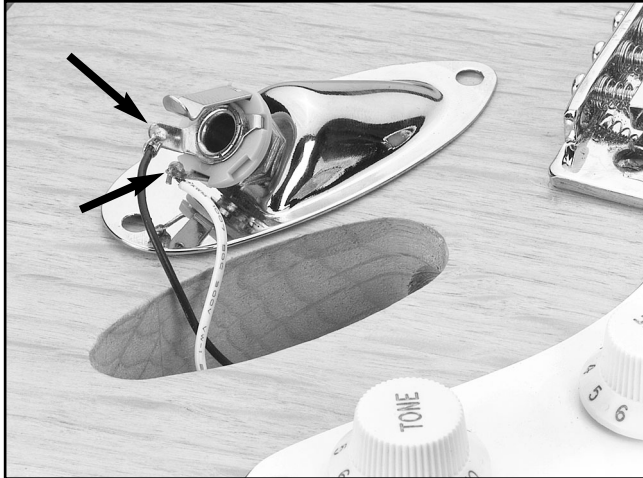

**Figure 26.** Soldered audio wire.

2. Turn the audio jack over and insert it in the cavity on the guitar body.
3. Secure the position of the audio jack to the guitar body with masking tape.
4. Using a  $\frac{3}{32}$ " drill bit, drill  $\frac{1}{2}$ " deep holes straight through the two holes in the audio jack. Note—*Drilling the holes deeper than  $\frac{1}{2}$ " could result in drilling out through the back of the guitar body.*
5. Secure the audio jack to the guitar body with the included two  $\frac{1}{2}$ " wood screws.



# Winding Strings

The correct position of the guitar strings is shown in **Figure 27**. The thin High E string is called the "1st" string and the thick Low E string is called the "6th" string.

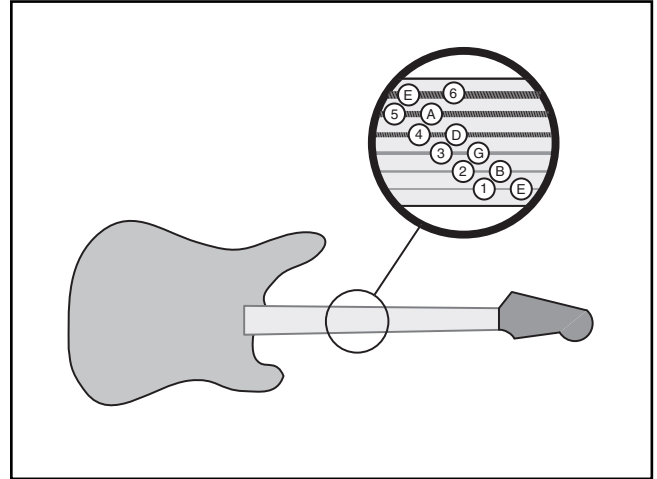

**Figure 27.** Correct string locations.

## To install the guitar strings:

1. Slide the 1st guitar string through the corresponding hole in the back plate (**Figure 28**).

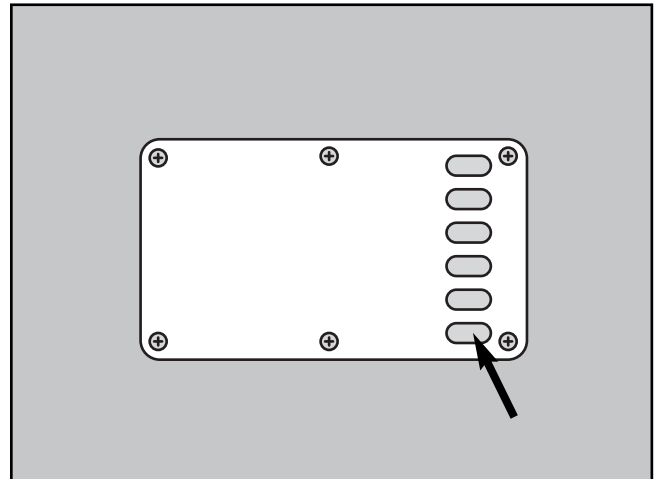

**Figure 28.** 1st string installation hole.

2. Guide the string over the string saddle on the tremolo bridge, over the string nut, and through the string hole in the corresponding machine head.
3. Allow only enough slack in the string for 2-3 rotations around the machine head. Note—*If too much slack is allowed, then the string could wind off the machine head after many successive rotations. If not enough slack is allowed, then the string may not hold the winding tension.*
4. Bend the string at a right angle across the edge of the machine head.
5. Rotate the tuning machine until the string just begins to hold the winding tension. Note—*DO NOT tighten the strings beyond the initial tensioning at this time. Final tensioning should be completed during the string tuning process.*
6. Use wire cutters to cut off the excess string.
7. Repeat the above process for the remaining strings.



## String Retainers

---



---

The short string retainer mounts between the 1st and 2nd strings and the taller spring retainer mounts between the 3rd and 4th strings (**Figure 29**).

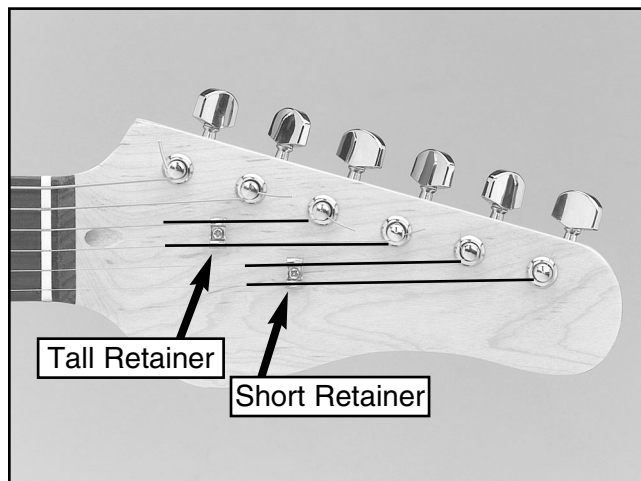

**Figure 29.** String retainer locations.

### To install the string retainers:

1. Secure the position of the string retainers to the headstock with masking tape.
2. Using a  $\frac{1}{16}$ " drill bit, drill  $\frac{1}{2}$ " deep holes straight through the holes in the string retainers. Note—*Drilling the holes deeper than  $\frac{1}{2}$ " could result in drilling out through the front face of the headstock.*
3. Secure the string retainers to the guitar with the included two  $\frac{1}{2}$ " wood screws.



# Mounting Pick Guard

---

---

## To secure the pick guard to the guitar body:

1. Position the pick guard so the 1st string is centered over the corresponding round metal pick-up peg as shown in **Figure 30**.



**Figure 30.** Pick guard mounting location.

2. Secure the position of the pick guard to the guitar body with masking tape.
3. Using a  $\frac{3}{32}$ " drill bit, drill  $\frac{1}{2}$ " deep holes straight through the eleven holes in the pick guard. Note—*Drilling the holes deeper than  $\frac{1}{2}$ " could result in drilling out through the back of the guitar body.*
4. Secure the pick guard to the guitar body with the included eleven  $\frac{1}{2}$ " wood screws.



# Mounting Back Plate

---

---

Once mounted, the six holes in the back plate need to align with the six holes in the tremolo bridge. This will simplify the string installation and removal process.

## To mount the back plate to the guitar body:

1. Position the back plate over the cavity in the back of the guitar body as shown in **Figure 31**.

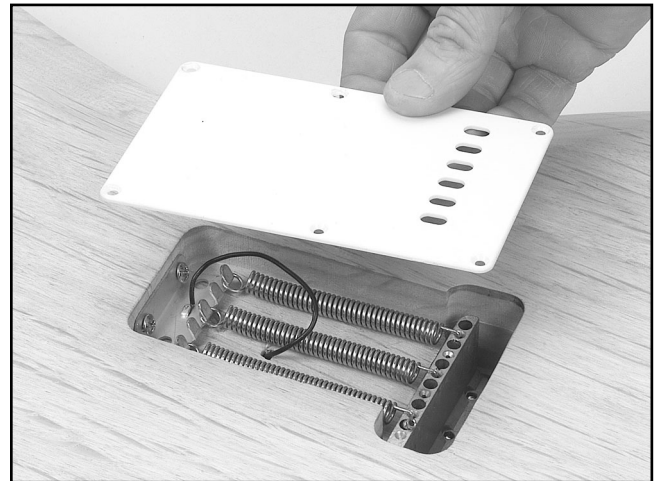

**Figure 31.** Mounting the back plate.

2. Secure the position of the back plate to the guitar body with masking tape.
3. Using a  $\frac{3}{32}$ " drill bit, drill  $\frac{1}{2}$ " deep holes straight through the six holes in the back plate. Note—*Drilling the holes deeper than  $\frac{1}{2}$ " could result in drilling out through the front of the guitar body.*
4. Secure the back plate to the guitar body with the included six  $\frac{1}{2}$ " wood screws.



# SECTION 6: FINAL SET UP

## Neck Adjustment

The guitar neck was adjusted perfectly straight before it was packaged; however, the moisture content of wood acclimates to the humidity of the surrounding environment. This characteristic results in movement of the wood components with regards to alignment. It is not uncommon for the neck to require adjustment several times each year, especially in regions where the seasonal climate changes are more drastic.

If your guitar neck is no longer straight, have it adjusted by a qualified guitar technician.



## String Height

Correct string height is crucial for maximizing the playability of your new electric guitar. The string height is the distance between the top face of the fret and the bottom face of the string (**Figure 32**).

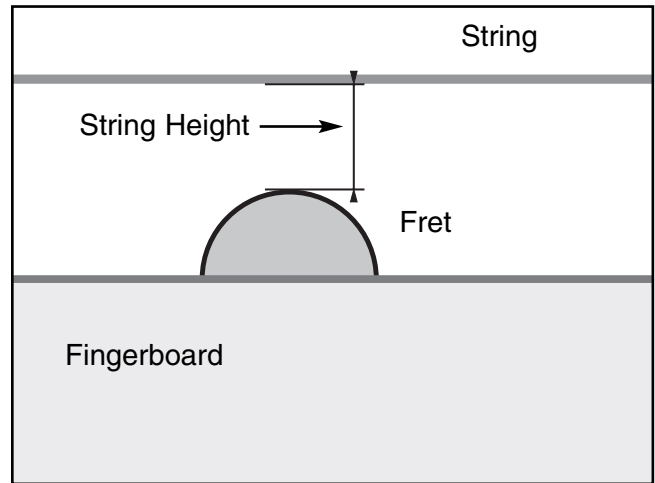

**Figure 32.** String height measurement (side view).

Measurements are taken at the following locations. Note—Use a steel ruler with a resolution of at least  $\frac{1}{64}$ ".

- **1st fret:** 1st string, 6th string
- **12th fret:** 1st string, 6th string

To check the string heights of the 1st and 6th strings at the 1st fret:

1. Measure the string heights at the 1st fret (**Figure 33**).

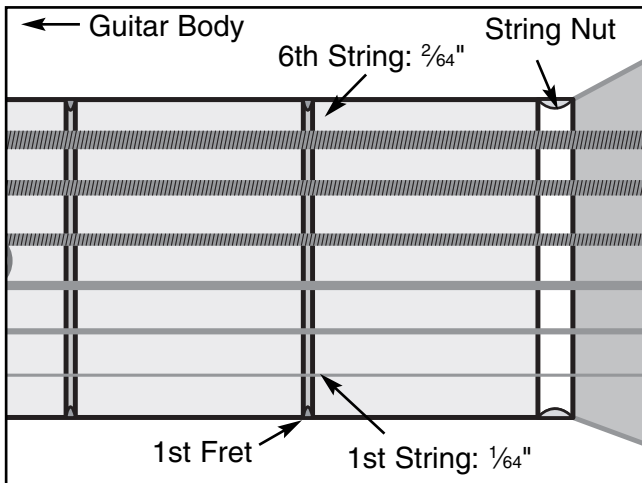
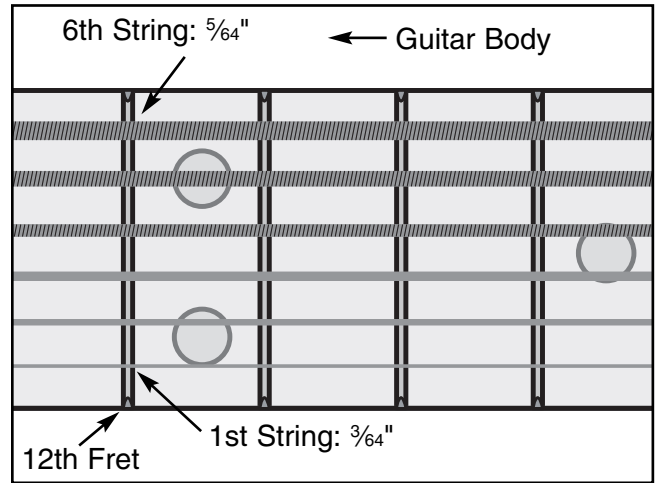

**Figure 33.** Correct 1st fret string heights.

- If the string heights are correct (**Figure 33**), then move to checking the string heights at the 12th fret.
- If the string heights are incorrect at the 1st fret, this is an indication that the groove the string nut sits in needs to be either deepened or made shallower. This condition is most likely a result of wood movement due to humidity changes in the environment. We recommend having a qualified guitar technician raise or lower the nut before continuing with string height adjustment at the 12th fret.

To check the string heights of the 1st and 6th strings at the 12th fret:

1. Measure the string heights at the 12th fret (**Figure 34**).



**Figure 34.** Correct 12th fret string heights.

- If the string heights are correct, then continue to the next sub-section.
  - If the string heights are incorrect at the 12th fret, then continue to the next step.
2. With the supplied 1.5mm Allen wrench, adjust the string saddle setscrews until the string heights are correct.
    - Turn the screws clockwise to raise the height of the string saddle; therefore, increasing the string height.
    - Turn the screws counterclockwise to lower the height of the string saddle; therefore, decreasing the string height.
  3. Adjust the middle strings so they gradually increase in height from the 1st string height through the 6th string height.



# Pick Up Height

---

---

Pick up height can have a dramatic effect on the audio output signal. The closer the strings are to the pick ups, the higher the audio output signal will be. This can be ideal unless the strings are close enough to cause distortion due to magnetic interference caused by the electronic components. The pick up height was adjusted correctly before it was packaged; however, future adjustments may be needed.

## To measure the string height at the pick up:

1. Measure the height of the 1st and 6th strings at the pick up while the strings are “fretted” at the 22nd fret (**Figure 35**). Note—*Use a steel ruler with a resolution of at least  $\frac{1}{32}$ ”.*

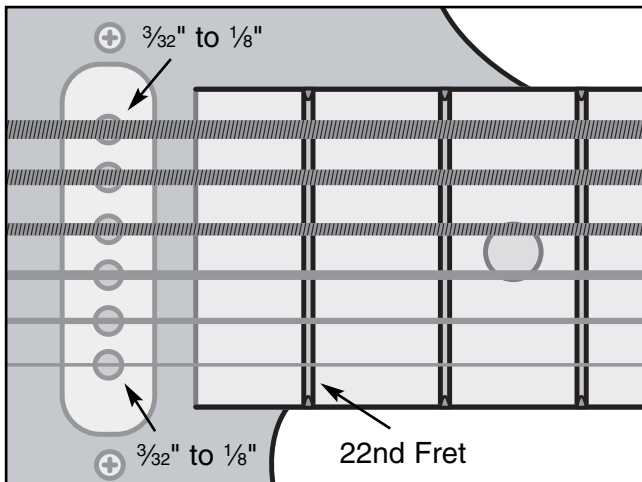

**Figure 35.** Correct string heights over the pick up while the strings are fretted on the 22nd fret.

— If the string height is between  $\frac{3}{32}$ " and  $\frac{1}{8}$ ", then the pick up is adjusted correctly. Continue to the next sub-section.

— If the pick up does not fall within the above heights, then continue to the next step.

2. With a phillips head screwdriver, adjust the screws on each side of the pick up (**Figure 35**) until the string heights are correct.

- Turn the screws clockwise to raise the height of the pick up, therefore, decreasing the string height.

- Turn the screws counterclockwise to lower the height of the pick up, therefore, increasing the string height.



# Tremolo Arm

Screw the tremolo arm into the mounting location shown in **Figure 36**.



**Figure 36.** Installing the tremolo arm.



# Tuning

Tuning is the most important concept of playing a guitar. If the guitar is not in tune with itself, or the other instruments in an ensemble, the resulting music will not sound pleasing to the ear. Having a good understanding of tuning is essential to maximizing the full potential of any guitar.

**Important issues to consider when tuning a guitar:**

- Get into the habit of tuning the guitar every time it is picked up to be played.
- Always tune the strings “up.” The final tuned tension of each string should be reached while tightening the string, not loosening it. If the string is tensioned too far, loosen the tension and tune “up” again.
- The goal when tuning is to make the strings in tune with one another. Standard tuning is shown in **Figure 37**.

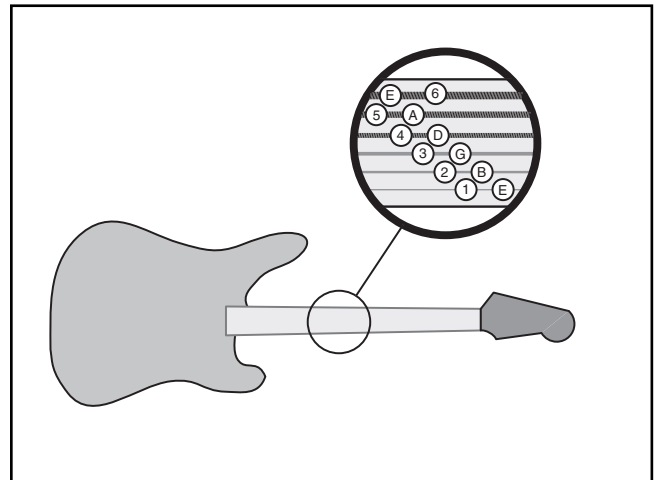

**Figure 37.** String tuning notes.

- The easiest way to tune a guitar is using an electronic tuner such as the Grizzly H3097 Chromatic Tuner shown on **page 24**. However, knowing how to tune a guitar by ear is an important part of being an accomplished guitar player.



### To tune the guitar:

1. Play a known Low E pitch. A piano, a tuning fork, or an electronic computer file will work.
2. Play an open (non-fretted) 6th string. The goal is to match the open 6th string to the known Low E pitch.
3. Adjust the tuning peg until the pitch of the open 6th string sounds exactly like the known Low E source.  
  
— If the string is tuned too high, back the tension off and retune the string back up to match the Low E pitch. Now the other strings can be tuned to the 6th string.
4. Next, the 5th string needs to be tuned. The tone of the 5th string must be matched to the tone of the 6th string by playing the same note on each string, one after another. This is done by playing the 6th string while it is being pressed (fretted) at the 5th fret, and immediately after, playing the open 5th string.
5. Listen to the two tones. As the two notes are still resonating, adjust the tuning peg of the 5th string until the two notes have matching tones. Remember to tune “up.”
6. Perform the same tuning steps on the 4th and 3rd strings.
7. When tuning the 2nd string, the 3rd string should be fretted at the 4th fret instead of the 5th fret.
8. Tune the 1st string in the same manner as the 6th, 5th, 4th, and 3rd strings.



# SECTION 7: REFERENCE INFO

## General

This section contains the following subsections for the Model H3123: aftermarket accessories, data sheets, wiring diagrams, parts diagrams and list, troubleshooting, and warranty/return information.

If you need parts or help in assembling your machine, or if you need operational information, call the service department at (570) 546-9663. Trained service technicians will be glad to help you.

If you have any comments regarding this manual, please write to Grizzly at the address below:

Grizzly Industrial, Inc.  
% Technical Documentation  
P.O. Box 2069  
Bellingham, WA 98227-2069

We recommend you keep a copy of our current catalog for complete information regarding Grizzly's warranty and return policy. If you need additional technical information relating to this machine, or if you need general assistance or replacement parts, please contact the Service Department at the location listed below.

Grizzly Industrial, Inc.  
1203 Lycoming Mall Circle  
Muncy, PA 17756  
Phone: (570) 546-9663  
Fax: (800) 438-5901  
E-Mail: [techsupport@grizzly.com](mailto:techsupport@grizzly.com)  
Web Site: <http://www.grizzly.com>



## Aftermarket Accessories



Figure 38. H3097 Chromatic Tuner.

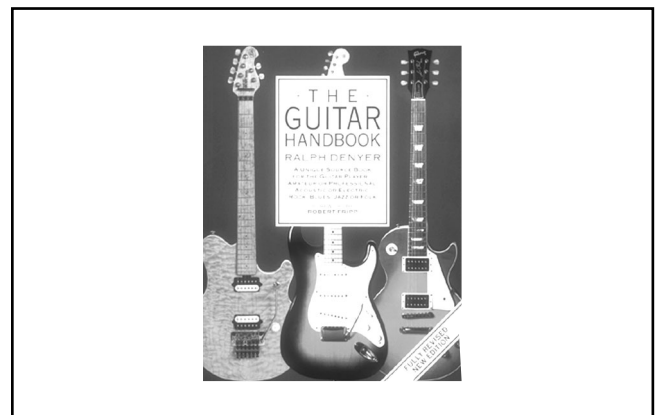

Figure 39. H4412 *The Guitar Handbook*.

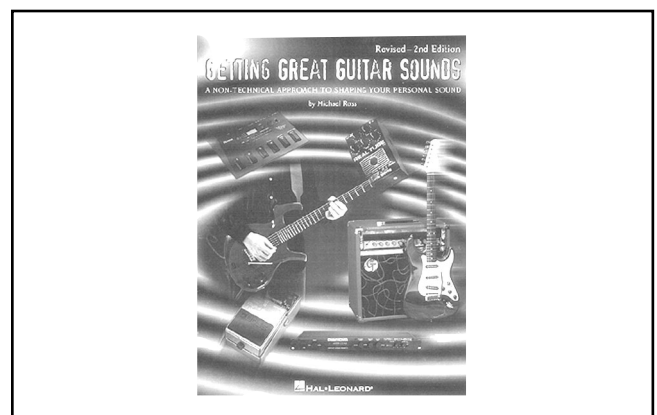

Figure 40. H4414 *Getting Great Guitar Sounds*.



# Notes

---

# Warranty & Returns

---

---

Grizzly Industrial, Inc. warrants every product it sells for a period of **1 year** to the original purchaser from the date of purchase. This warranty does not apply to defects due directly or indirectly to misuse; abuse; negligence; accidents; repairs or alterations; assembly, finishing or modification of kits; or lack of maintenance. This is Grizzly's sole written warranty and any and all warranties that may be implied by law, including any merchantability or fitness, for any particular purpose, are hereby limited to the duration of this written warranty. We do not warrant or represent that the merchandise complies with the provisions of any law or acts unless the manufacturer so warrants. In no event shall Grizzly's liability under this warranty exceed the purchase price paid for the product and any legal actions brought against Grizzly shall be tried in the State of Washington, County of Whatcom.

We shall in no event be liable for death, injuries to persons or property or for incidental, contingent, special, or consequential damages arising from the use of our products.

To take advantage of this warranty, contact us by mail or phone and give us all the details. We will then issue you a "Return Number," which must be clearly posted on the outside as well as the inside of the carton. We will not accept any item back without this number. Proof of purchase must accompany the merchandise.

The manufacturers reserve the right to change specifications at any time because they constantly strive to achieve better quality equipment. We make every effort to ensure that our products meet high quality and durability standards and we hope you never need to use this warranty.

Please feel free to write or call us if you have any questions about the machine or the manual.

Thank you again for your business and continued support. We hope to serve you again soon.

# WARRANTY CARD

Name \_\_\_\_\_  
Street \_\_\_\_\_  
City \_\_\_\_\_ State \_\_\_\_\_ Zip \_\_\_\_\_  
Phone Number \_\_\_\_\_ E-Mail \_\_\_\_\_ FAX \_\_\_\_\_  
MODEL # \_\_\_\_\_ Order # \_\_\_\_\_

The following information is given on a voluntary basis. It will be used for marketing purposes to help us develop better products and services. Of course, all information is strictly confidential.

1. How did you learn about us?  
 Advertisement  Friend  
 Catalog  Card Deck  
 World Wide Web  
 Other \_\_\_\_\_
2. Which of the following magazines do you subscribe to.  
 American Woodworker  Practical Homeowner  
 Cabinetmaker  Shop Notes  
 Family Handyman  Today's Homeowner  
 Fine Homebuilding  WOOD  
 Fine Woodworking  Wooden Boat  
 Home Handyman  Woodshop News  
 Journal of Light Construction  Woodsmith  
 Old House Journal  Woodwork  
 Popular Mechanics  Woodworker  
 Popular Science  Woodworker's Journal  
 Popular Woodworking  Workbench  
 Other \_\_\_\_\_
3. Which of the following woodworking/remodeling shows do you watch?  
 Backyard America  The New Yankee Workshop  
 Home Time  This Old House  
 The American Woodworker  Woodwright's Shop  
 Other \_\_\_\_\_
4. What is your annual household income?  
 \$20,000-\$29,999  \$60,000-\$69,999  
 \$30,000-\$39,999  \$70,000-\$79,999  
 \$40,000-\$49,999  \$80,000-\$89,999  
 \$50,000-\$59,999  \$90,000 +
5. What is your age group?  
 20-29  50-59  
 30-39  60-69  
 40-49  70 +
6. How long have you been a woodworker?  
 0 - 2 Years  8 - 20 Years  
 2 - 8 Years  20+ Years
7. How would you rank your woodworking skills?  
 Simple  Advanced  
 Intermediate  Master Craftsman
8. What stationary woodworking tools do you own? Check all that apply.  
 Air Compressor  Panel Saw  
 Bandsaw  Planer  
 Drill Press  Power Feeder  
 Drum Sander  Radial Arm Saw  
 Dust Collector  Shaper  
 Horizontal Boring Machine  Spindle Sander  
 Jointer  Table Saw  
 Lathe  Vacuum Veneer Press  
 Mortiser  Wide Belt Sander  
 Other \_\_\_\_\_
9. How many of your woodworking machines are Grizzly? \_\_\_\_\_
10. Which benchtop tools do you own? Check all that apply.  
 1" x 42" Belt Sander  6" - 8" Grinder  
 5" - 8" Drill Press  Mini Lathe  
 8" Table Saw  10" - 12" Thickness Planer  
 8" - 10" Bandsaw  Scroll Saw  
 Disc/Belt Sander  Spindle/Belt Sander  
 Mini Jointer  
 Other \_\_\_\_\_
11. How many of the machines checked above are Grizzly? \_\_\_\_\_
12. Which portable/hand held power tools do you own? Check all that apply.  
 Belt Sander  Orbital Sander  
 Biscuit Joiner  Palm Sander  
 Circular Saw  Portable Planer  
 Detail Sander  Saber Saw  
 Drill/Driver  Reciprocating Saw  
 Miter Saw  Router  
 Other \_\_\_\_\_
13. What machines/supplies would you like Grizzly Industrial to carry?  
\_\_\_\_\_  
\_\_\_\_\_
14. What new accessories would you like Grizzly Industrial to carry?  
\_\_\_\_\_  
\_\_\_\_\_
15. What other companies do you purchase your tools and supplies from?  
\_\_\_\_\_  
\_\_\_\_\_
16. Do you think your purchase represents good value?  
 Yes  No
17. Would you recommend Grizzly Industrial to a friend?  
 Yes  No
18. Would you allow us to use your name as a reference for Grizzly customers in your area? **Note: We never use names more than three times.**  
 Yes  No
19. Comments: \_\_\_\_\_  
\_\_\_\_\_  
\_\_\_\_\_  
\_\_\_\_\_

CUT ALONG DOTTED LINE

FOLD ALONG DOTTED LINE

---

---

---



Place  
Stamp  
Here



**GRIZZLY INDUSTRIAL, INC.**  
**P.O. BOX 2069**  
**BELLINGHAM, WA 98227-2069**



FOLD ALONG DOTTED LINE

Send a Grizzly Catalog to a friend:

Name_____
Street_____
City_____State_____Zip_____

TAPE ALONG EDGES--PLEASE DO NOT STAPLE



# *grizzly.com*

**TOOL WEBSITE**

Buy Direct and Save with Grizzly® – Trusted, Proven and a Great Value!

*Visit Our Website Today And Discover Why  
Grizzly® Is The Industry Leader!*

- SECURE ORDERING
- ORDERS SHIPPED WITHIN 24 HOURS
- E-MAIL RESPONSE WITHIN ONE HOUR

-OR-

Call Today For A **FREE**  
Full Color Catalog

**1-800-523-4777**

